

A SONOS

12 17 HH 03

A	B	C1	C2	C3	D
1	1217-2003	900	358	16	1/3
2	1217-2004	900	378	22	1/3
3	1217-1005	1274	358	16	2/3
4	1217-1006	1274	358	16	2/3
5	1217-1007	1274	323	16	2/3
6	1217-3003	503	336	16	1/3
7	1217-3004	502	280	16	1/3
8	1217-3005	346	280	16	1/3
9	1217-0003	1244	506	55	3/3
10	1217-0004	1244	350	55	3/3
11	1217-3006	500	284	6	3/3
12	1217-5001	1274	56	16	3/3
13	1217-5002	900	40	20	1/3
14	1217-9001	1284	514	3,7	3/3
15	1217-9002	1284	358	3,7	3/3

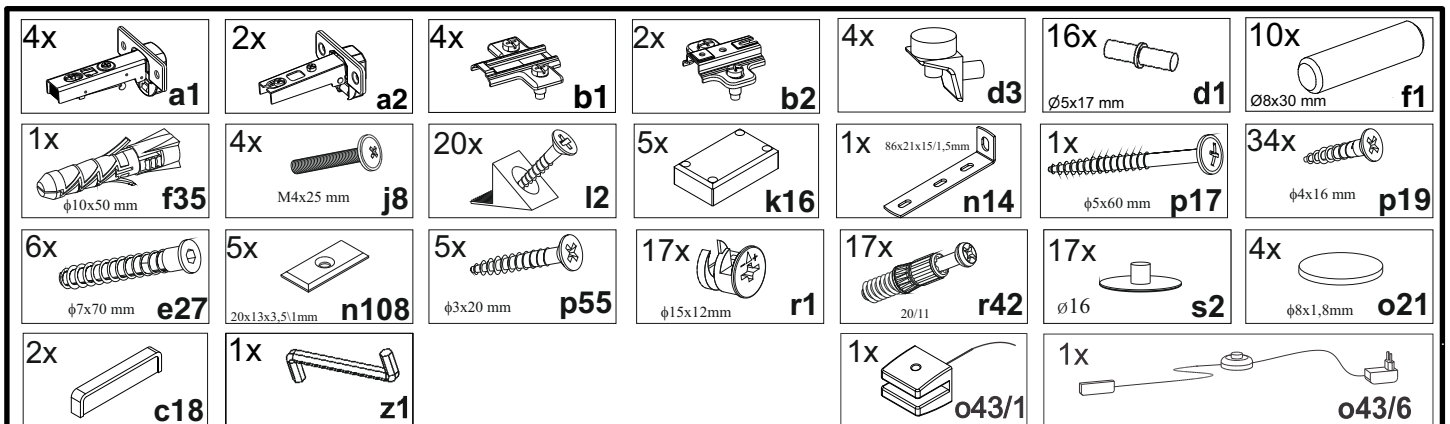

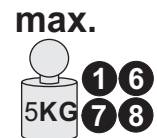
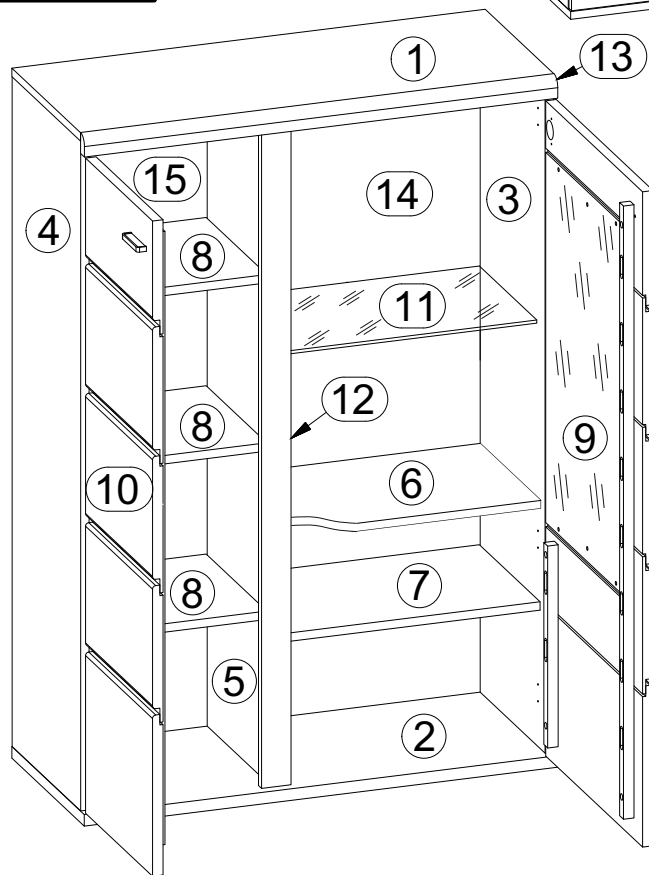
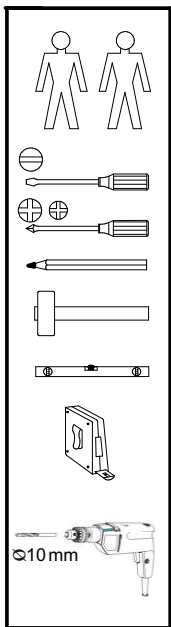
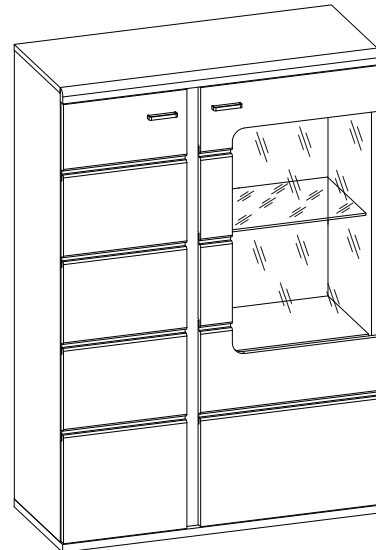
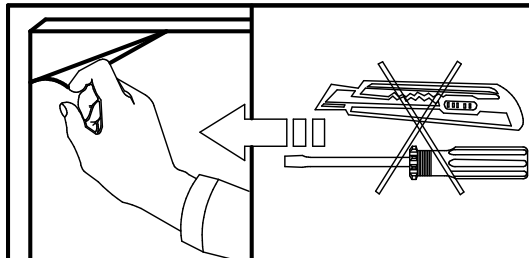
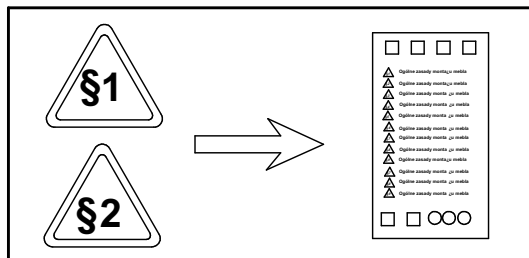
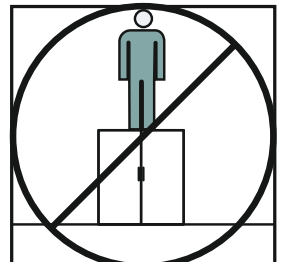
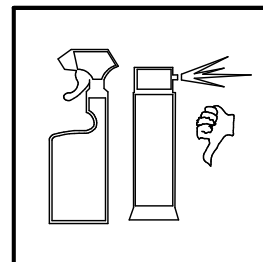
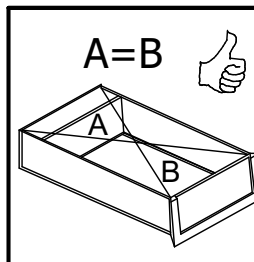
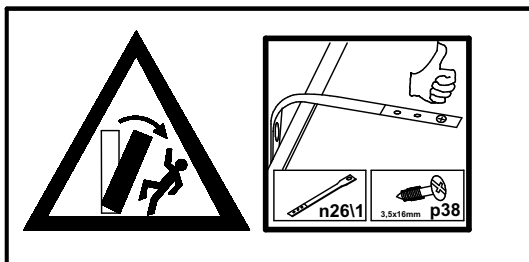
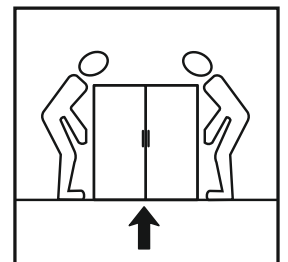
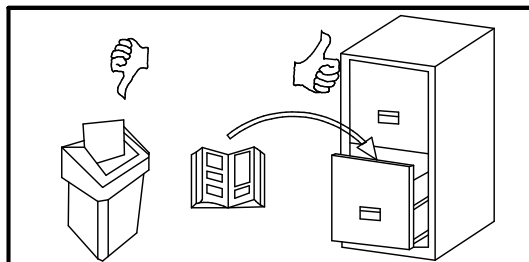
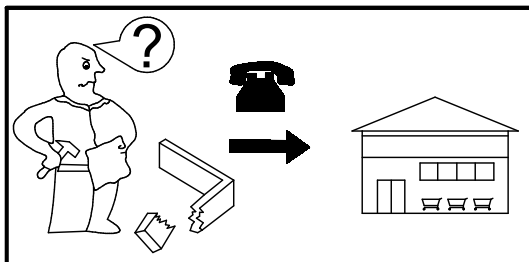
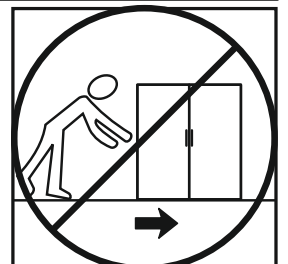
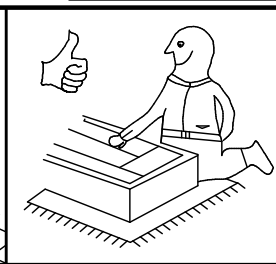
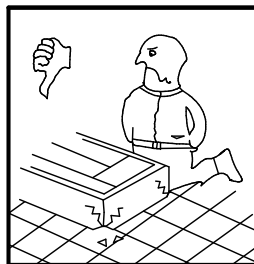
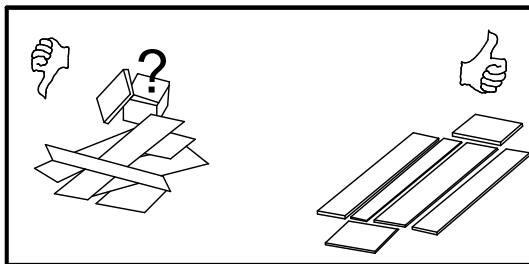
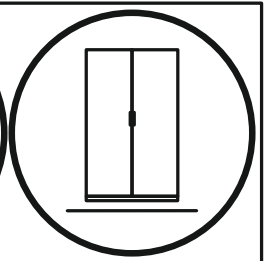
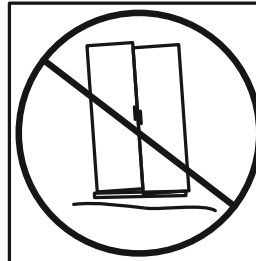
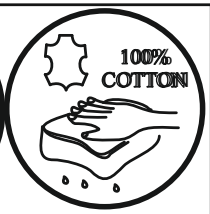
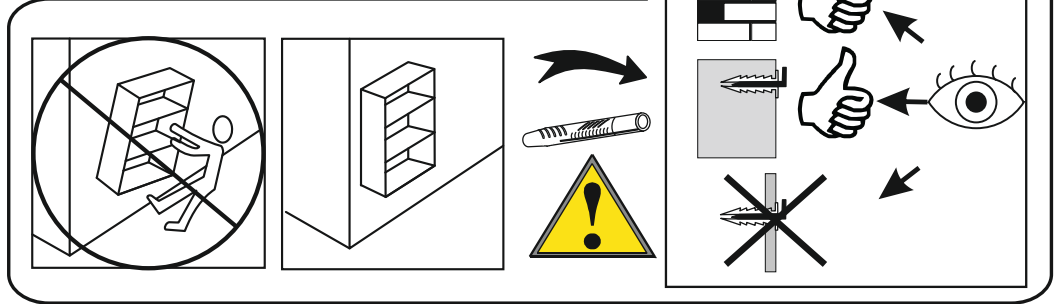
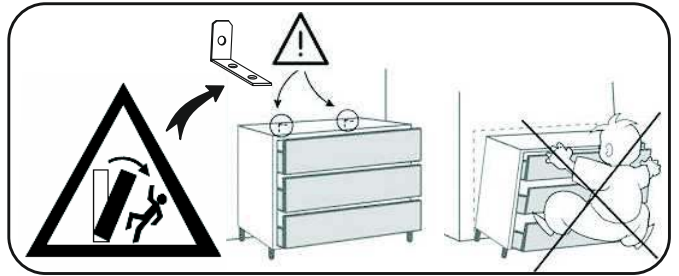
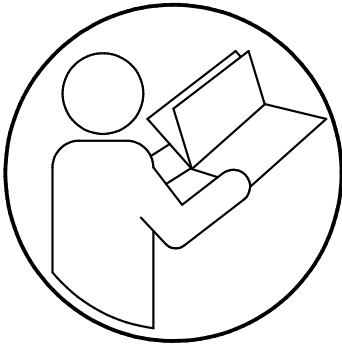

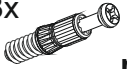

1 

8x  **r42**
20/11

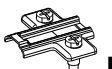
8x  **r1**
φ15x12mm

4x  **b1**

8x  **d1**
∅5x17 mm

2x  **b2**

2x  **d3**

4x  **f1**
∅8x30 mm

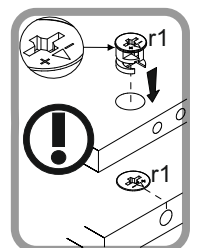
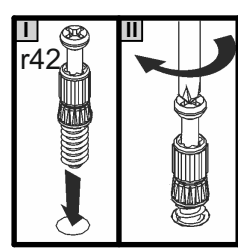
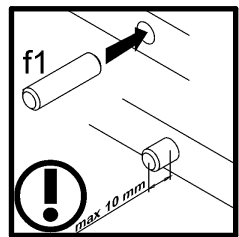
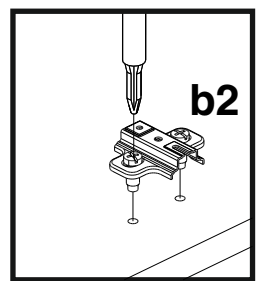
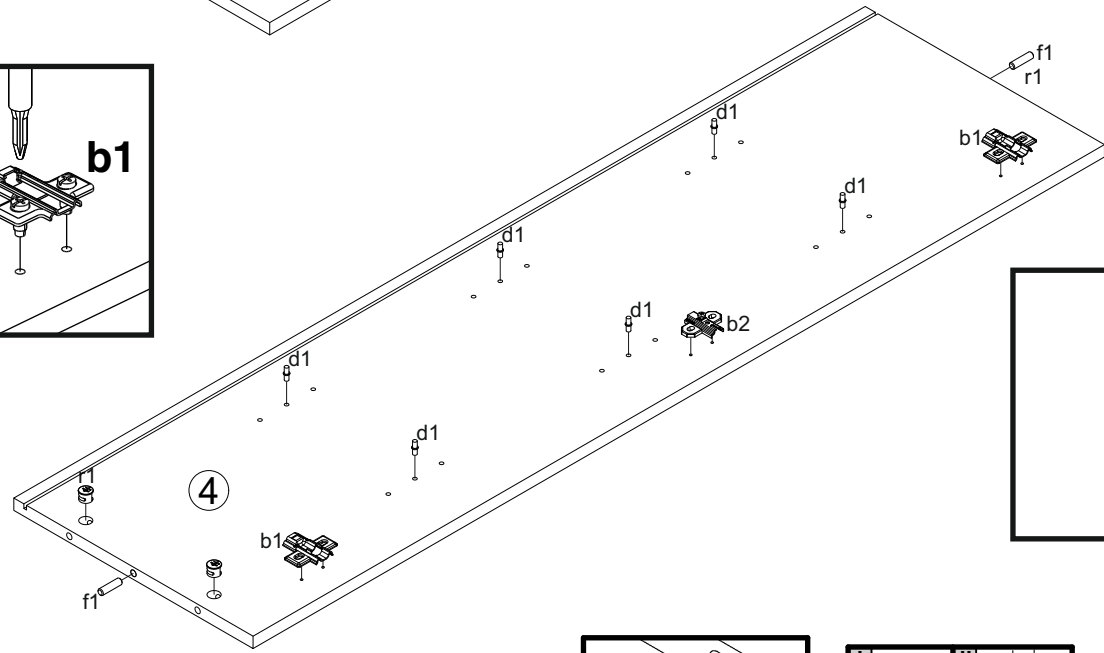
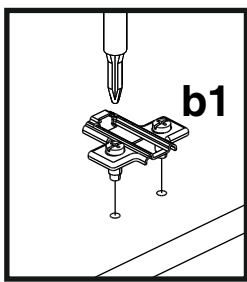
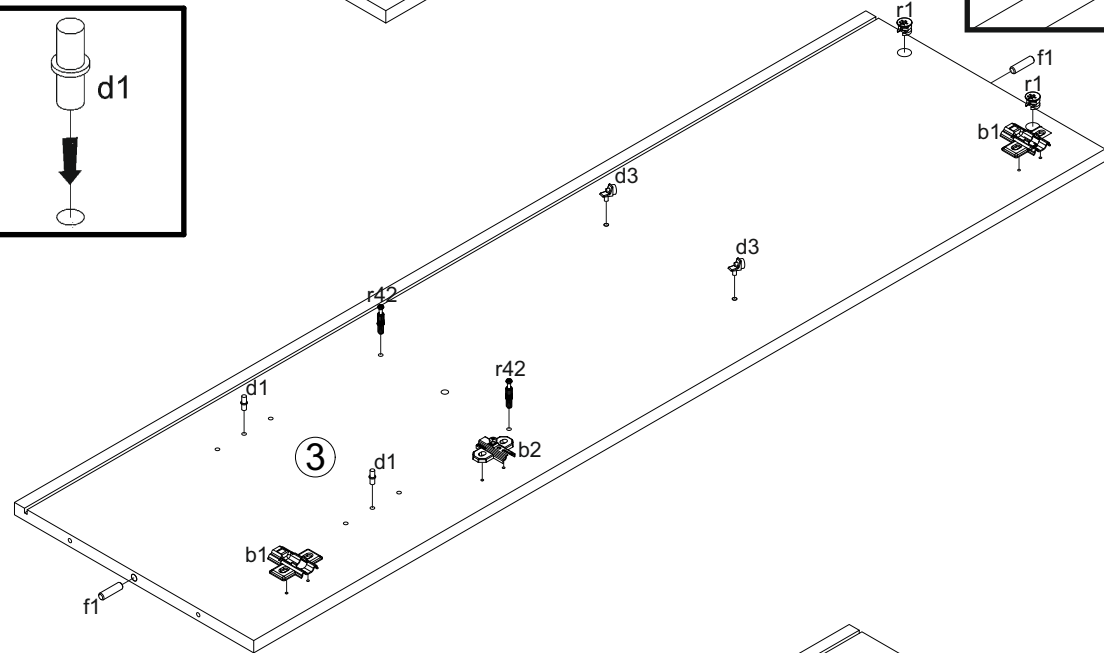
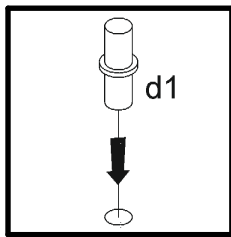
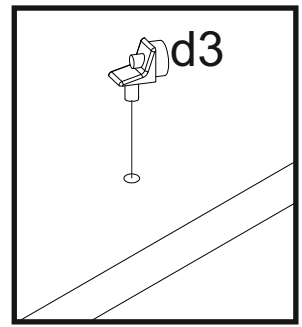
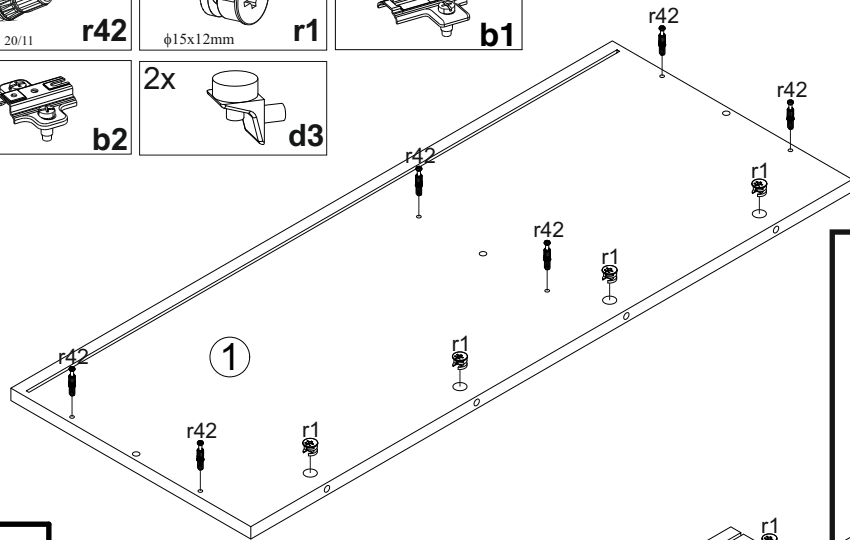

2

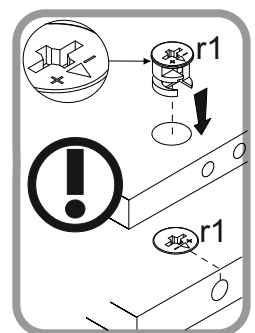
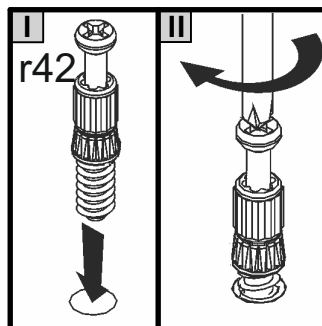
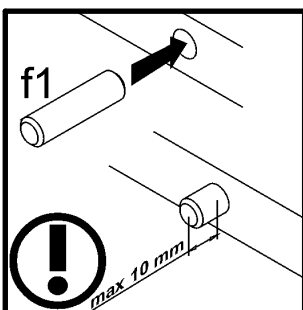
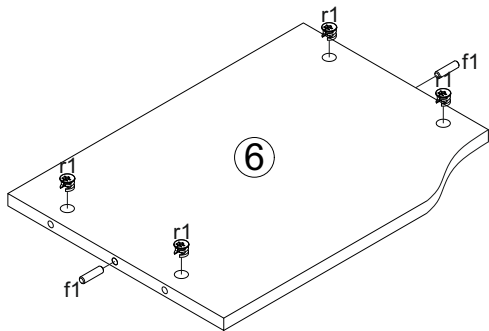
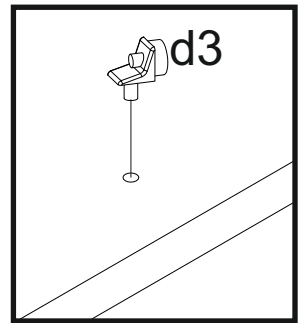
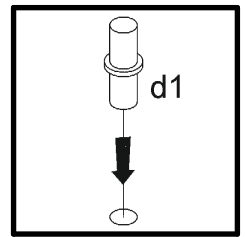
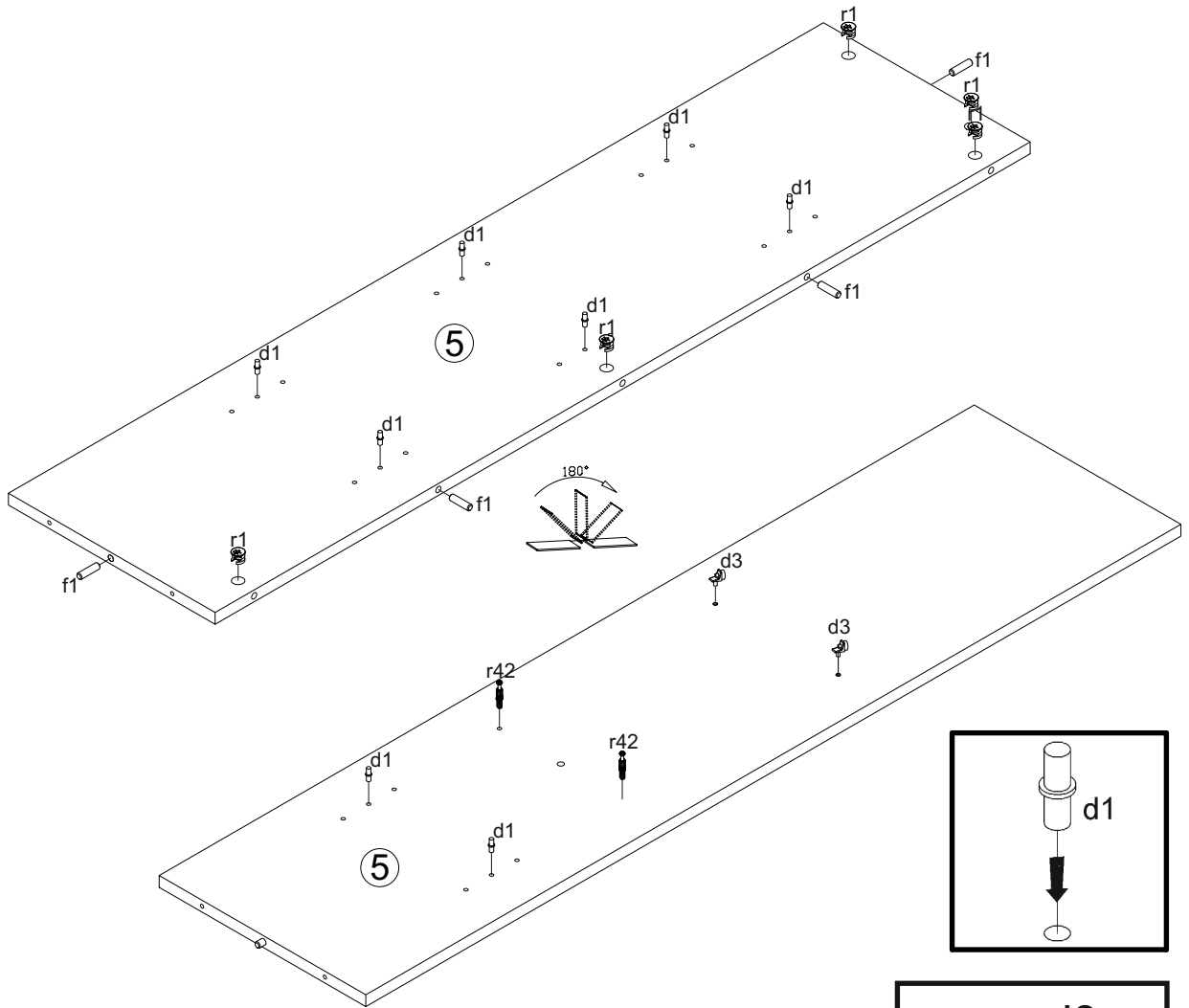
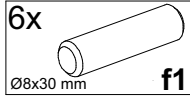
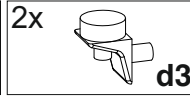
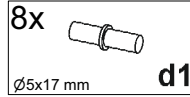
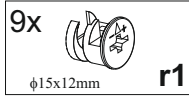
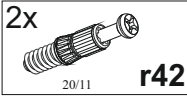

3

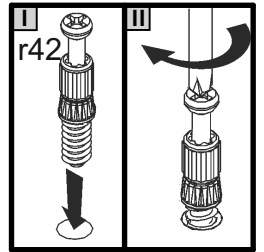
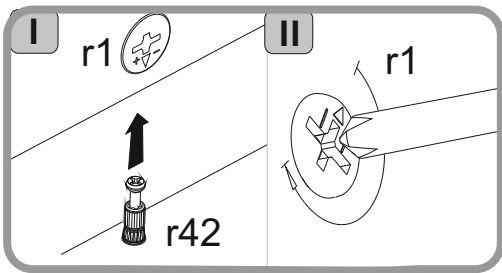
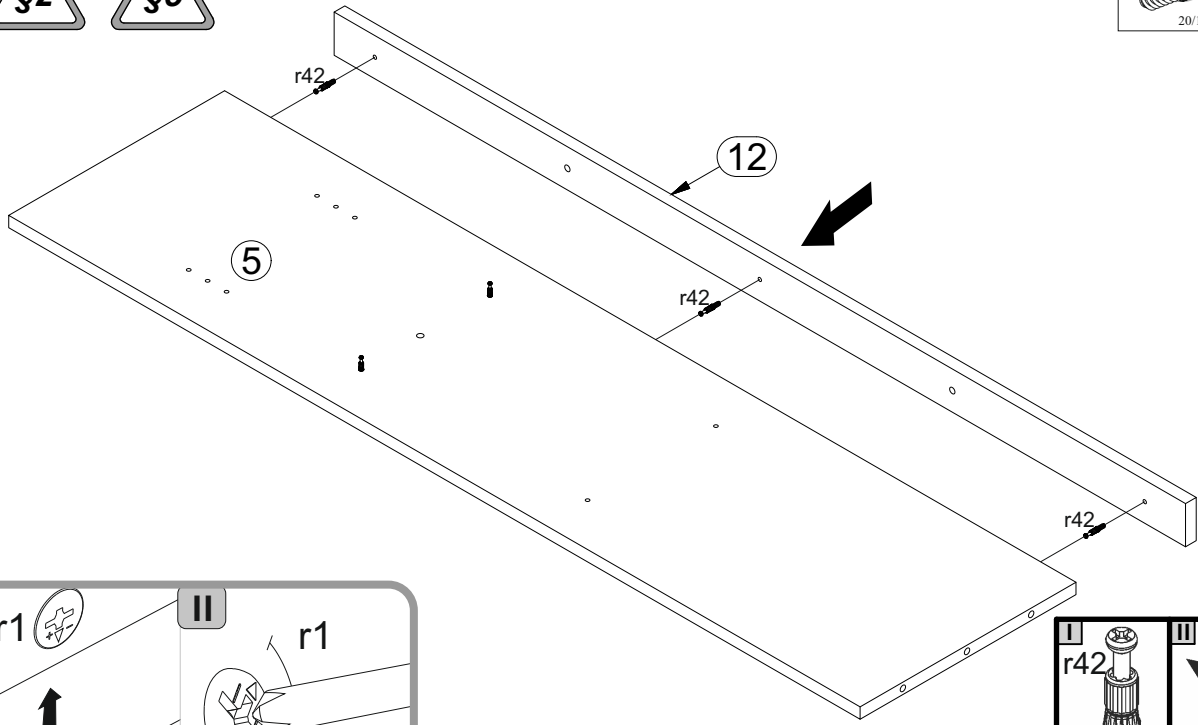

4

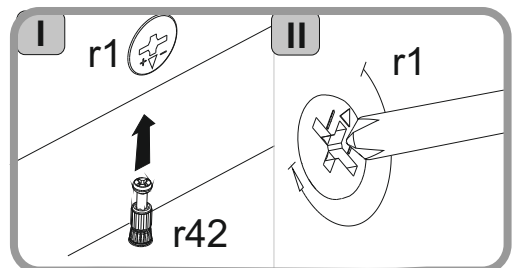
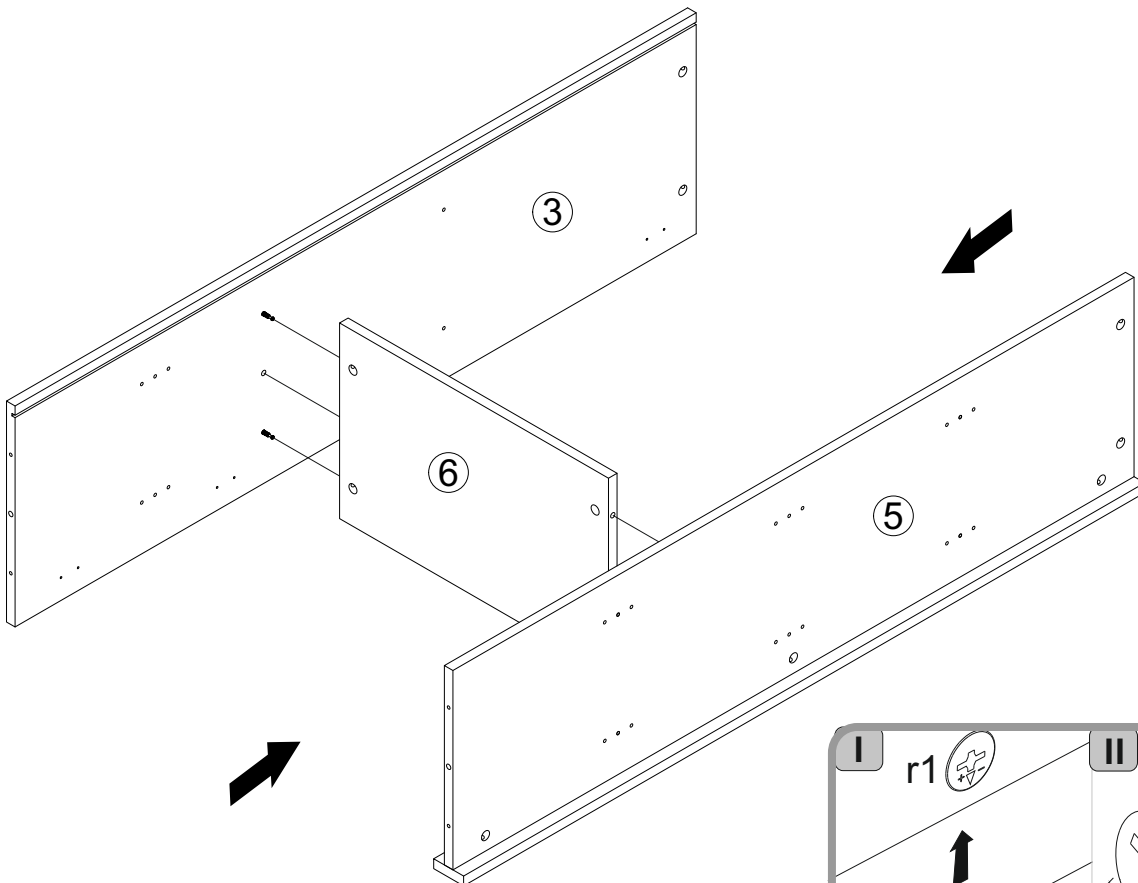

5

4x
20/11
r42

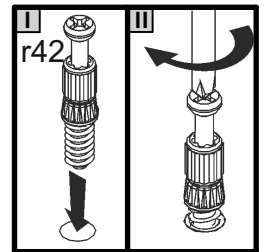
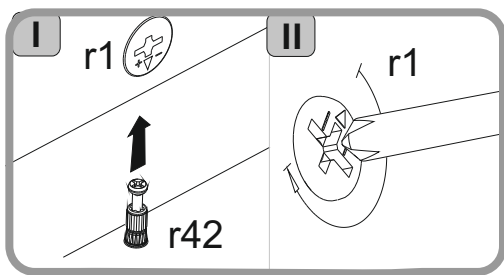
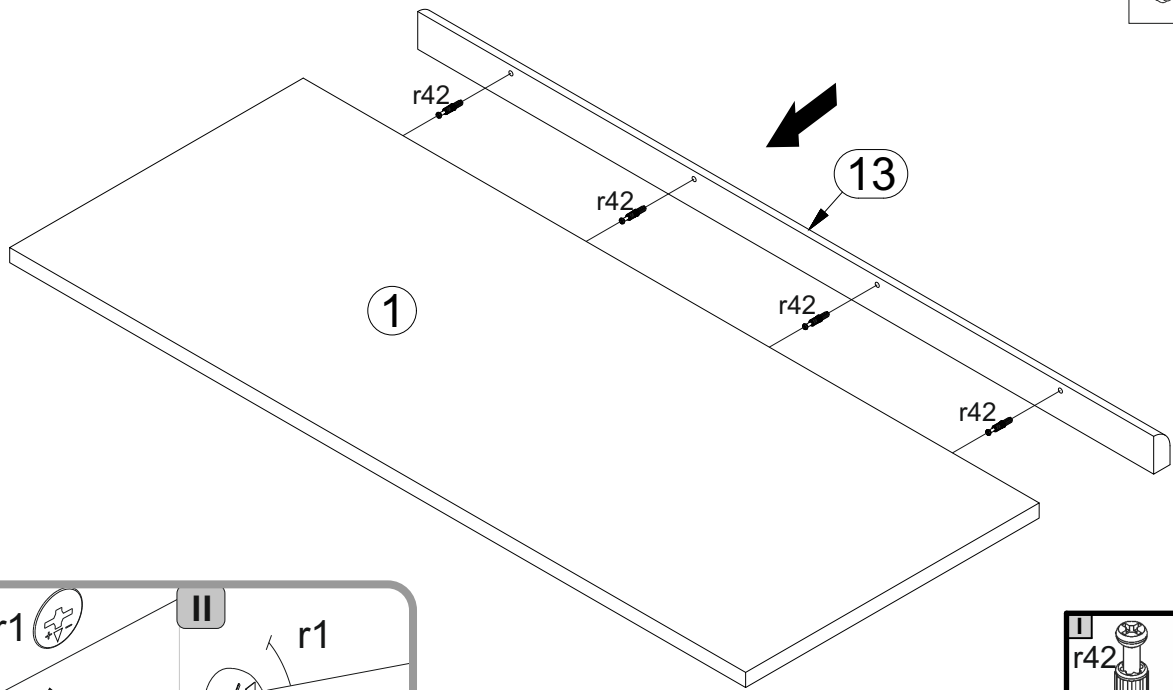

6

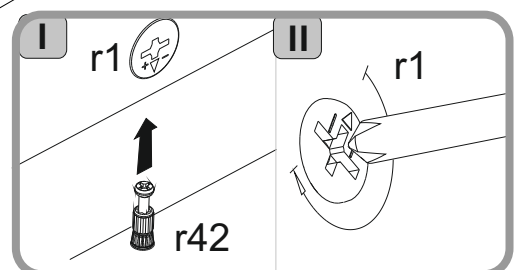
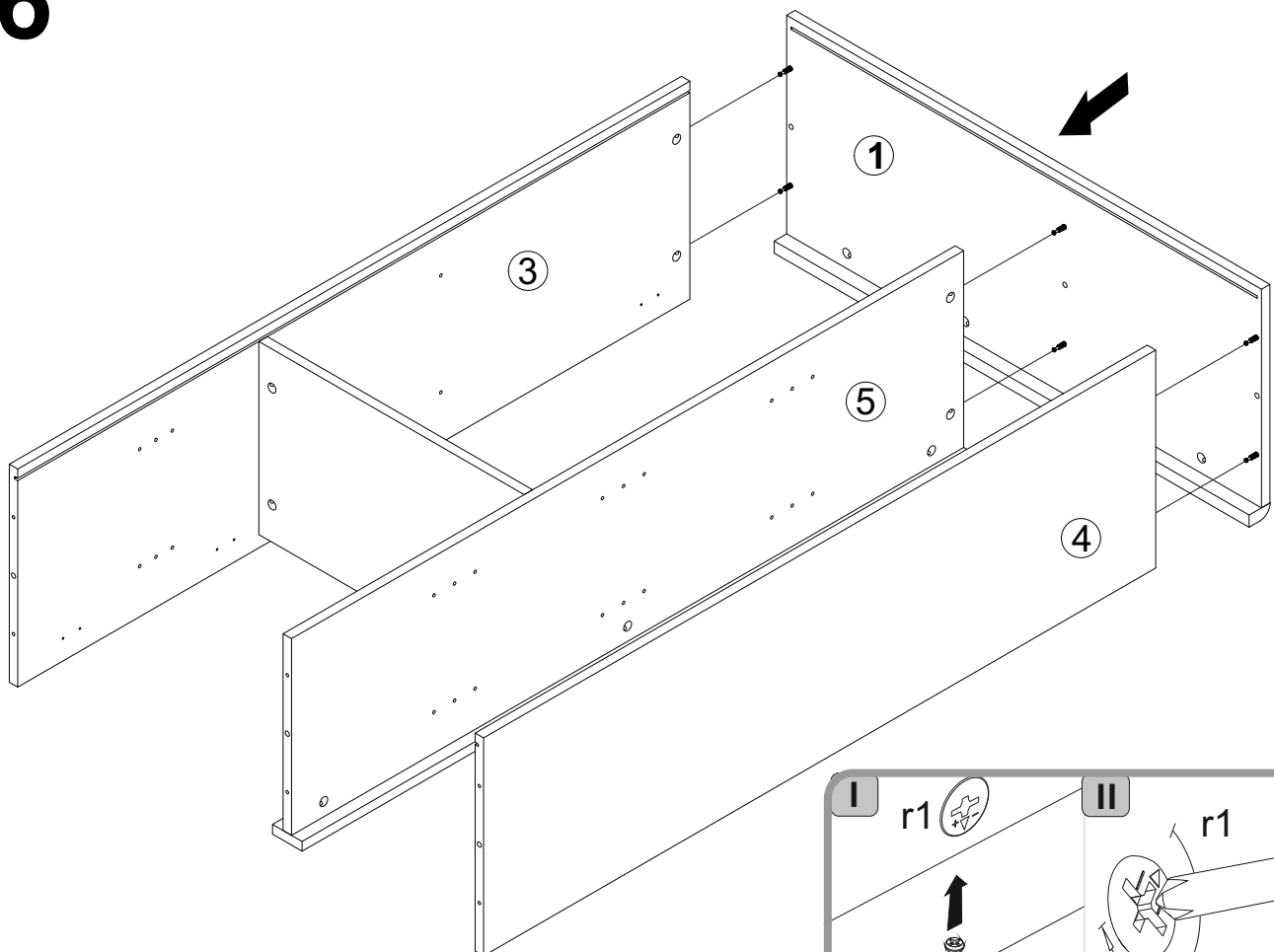

7

- 20x $\phi 4 \times 16 \text{ mm}$ **p19**
- 6x $\phi 7 \times 70 \text{ mm}$ **e27**
- 5x **k16**
- 1x **z1**

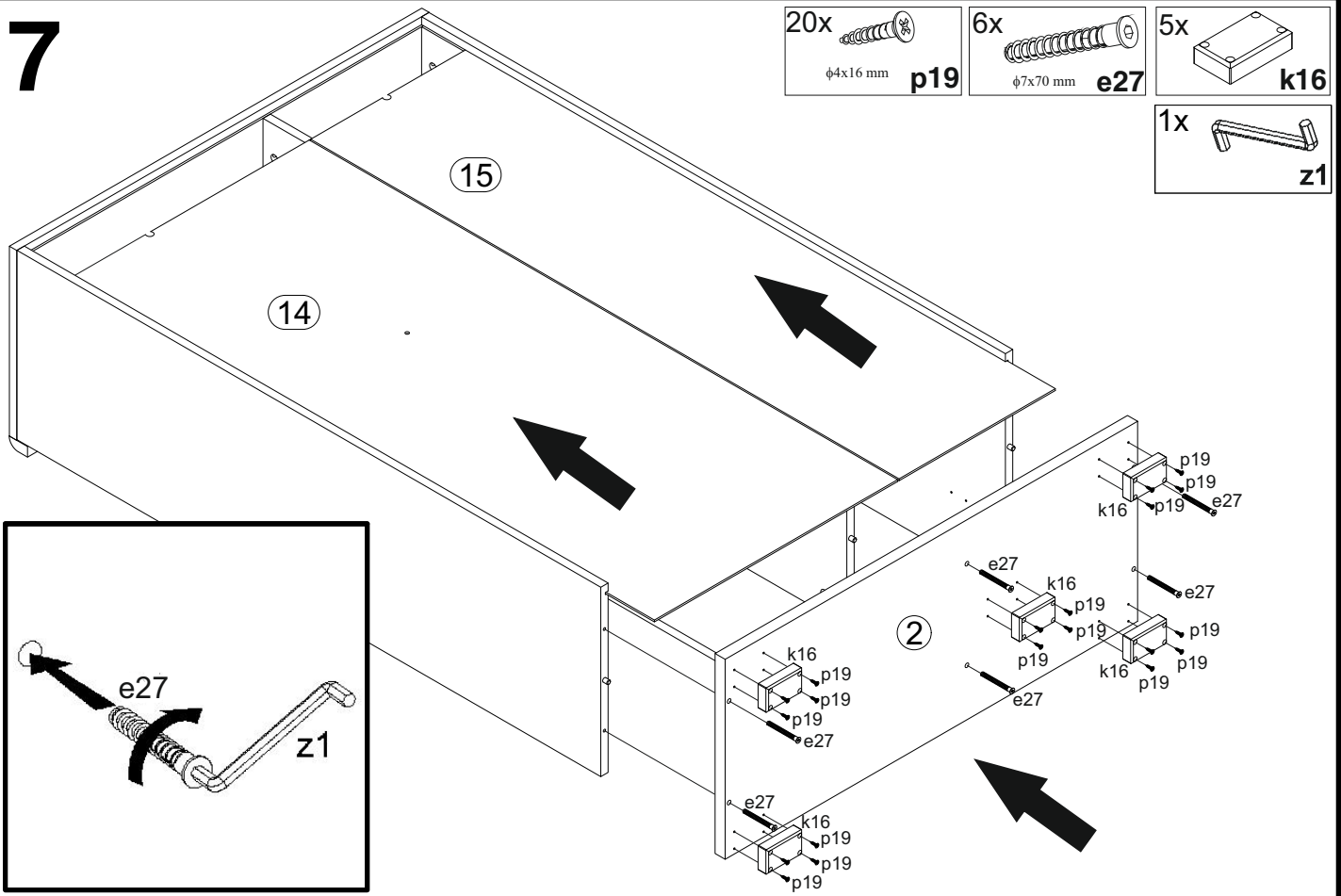

8

- 5x $\phi 3 \times 20 \text{ mm}$ **p55**
- 5x $20 \times 13 \times 3,5 \text{ mm}$ **n108**
- 20x **l2**

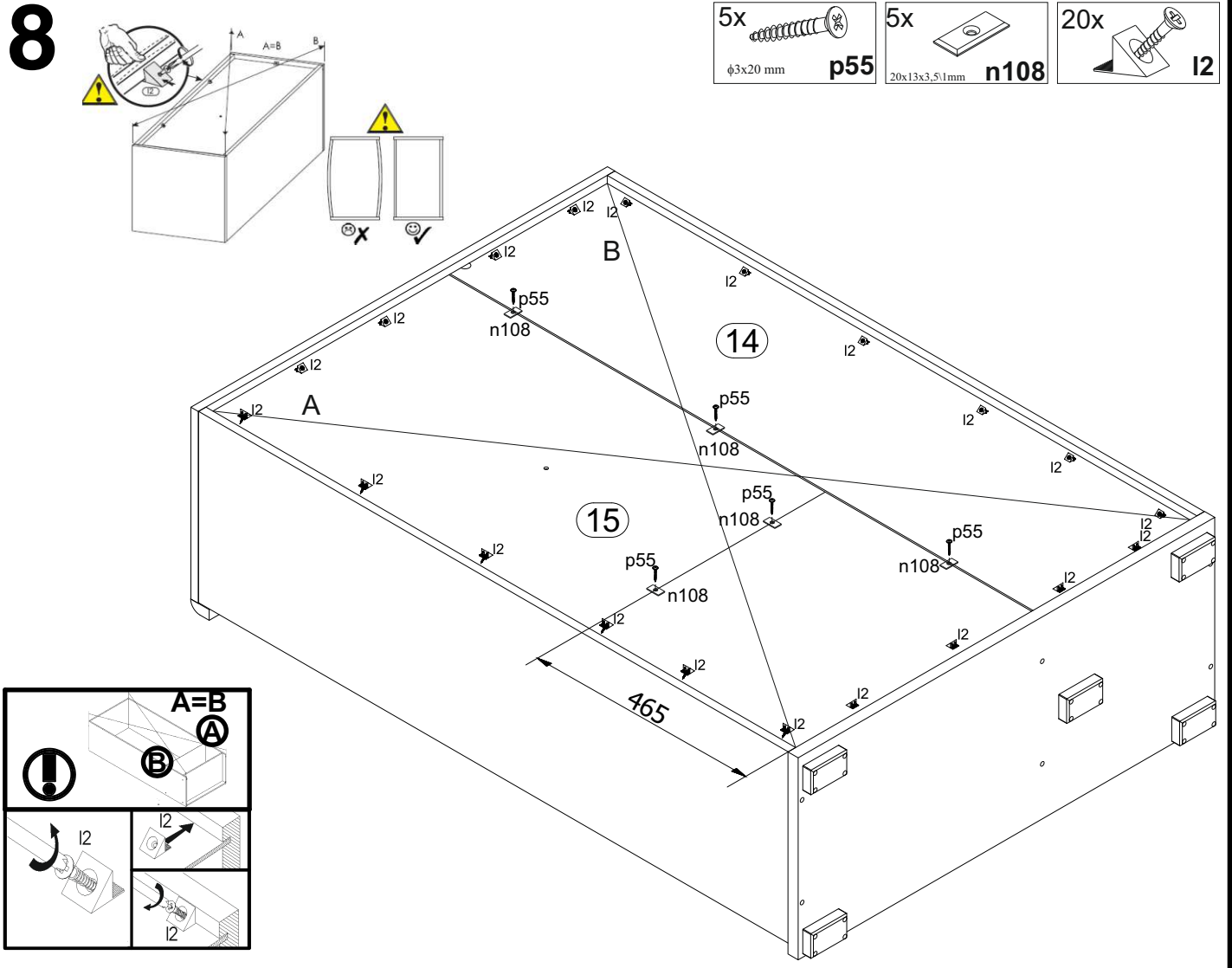

9

1x  o43/1

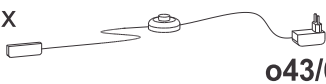
1x  o43/6

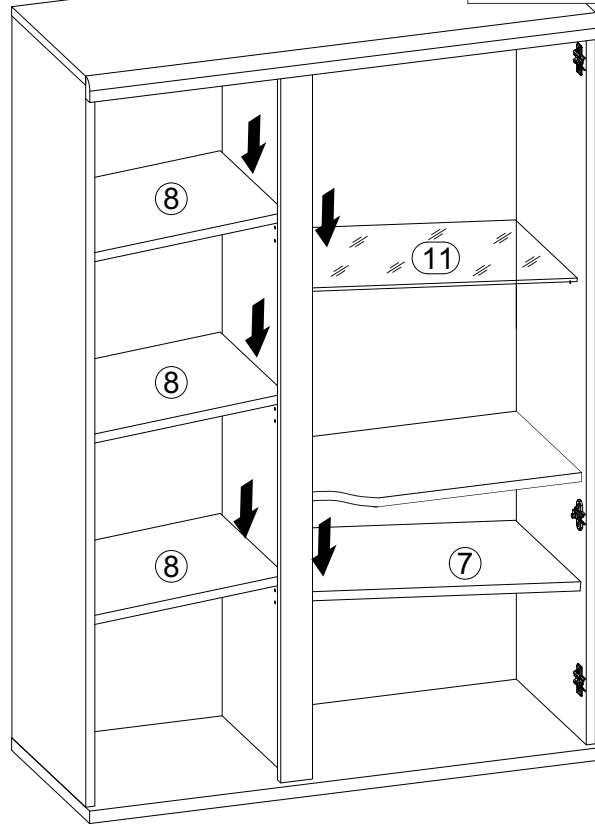
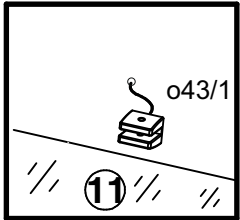
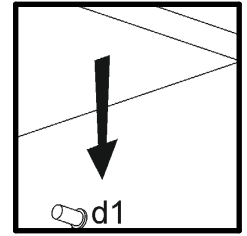
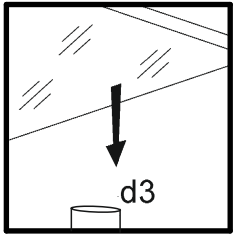

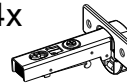

10

12x  p19
 $\phi 4 \times 16 \text{ mm}$

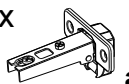
4x  a1

2x  a2

2x  c18

4x  j8
M4x25 mm

4x  o21
 $\phi 8 \times 1,8 \text{ mm}$

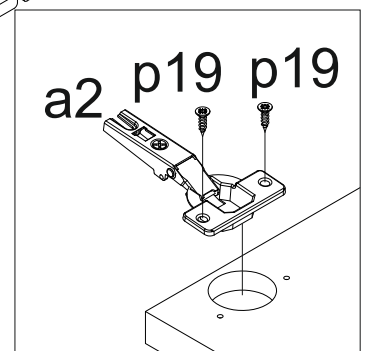
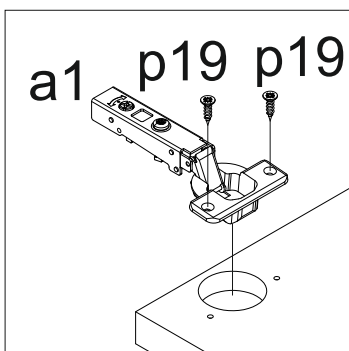
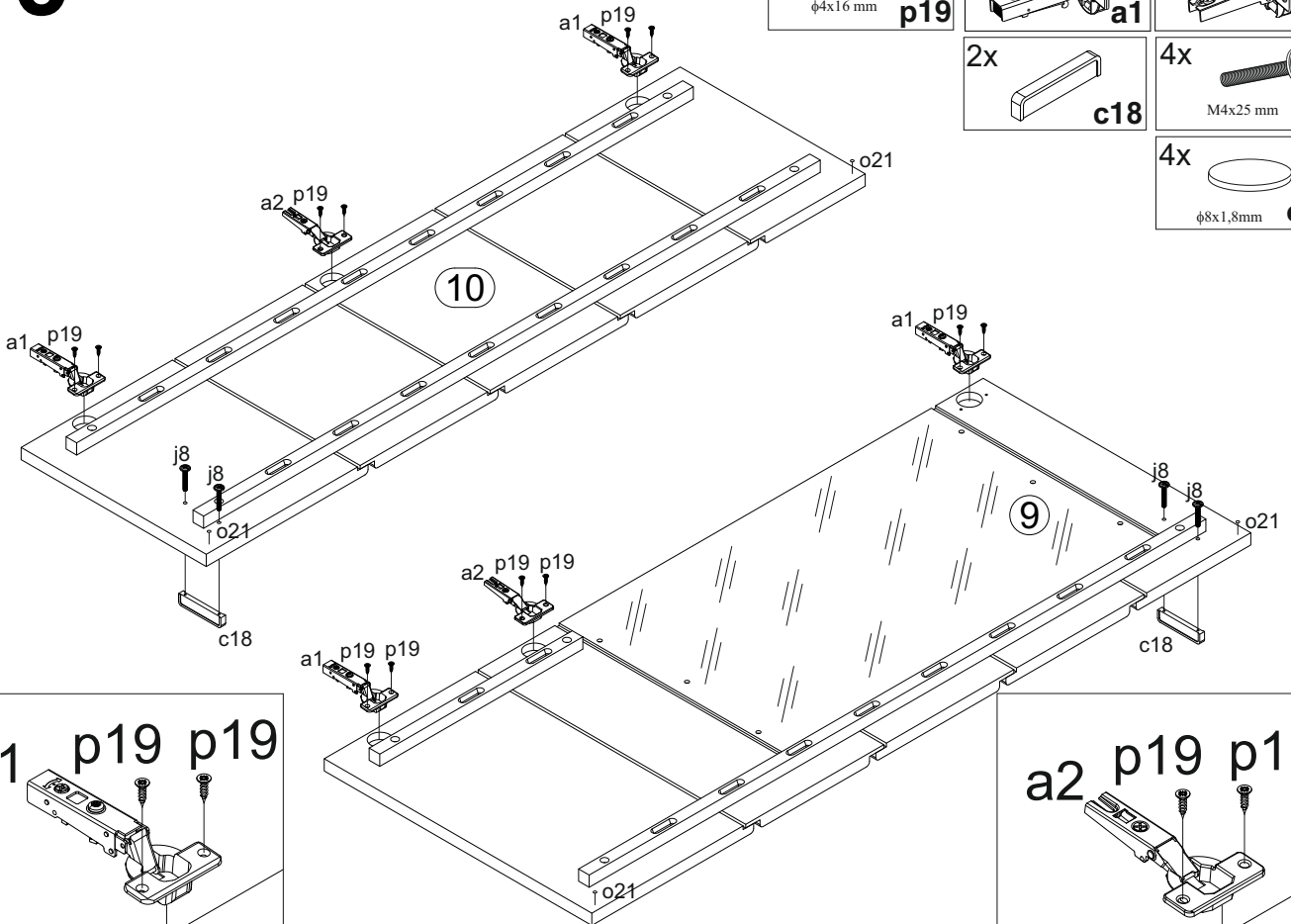

11

17x
ø16  s2

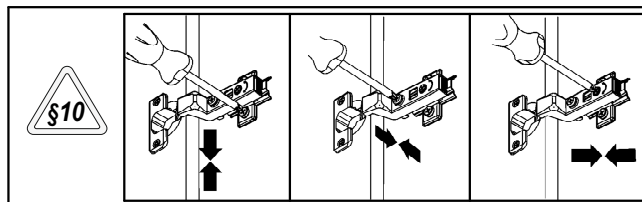
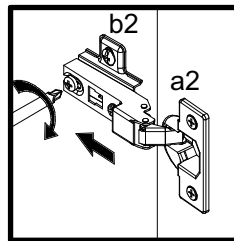
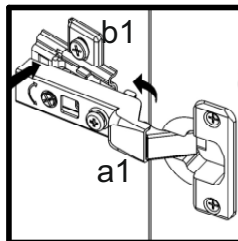
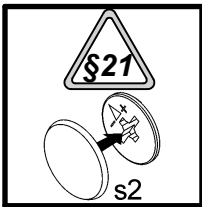
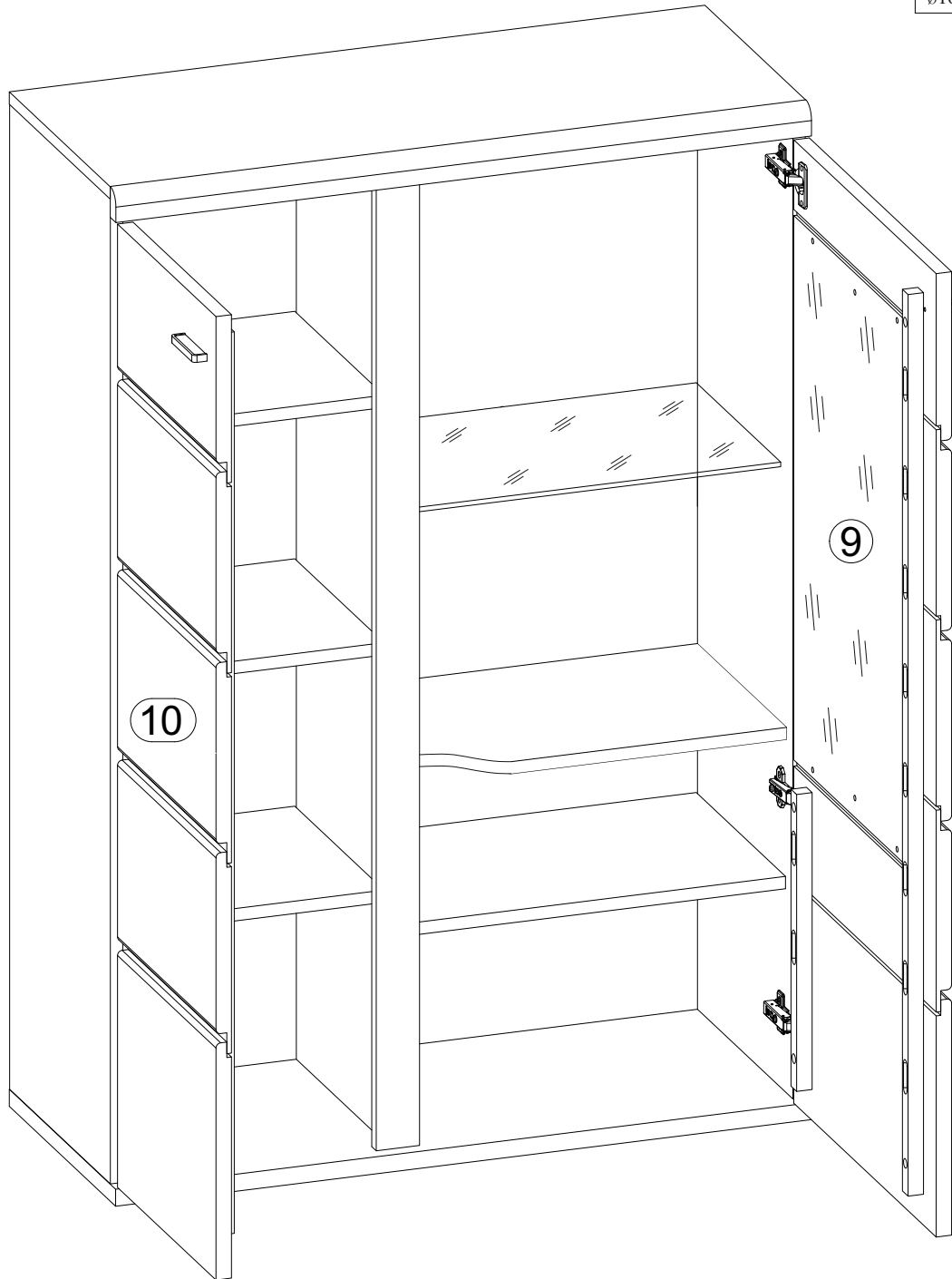

12

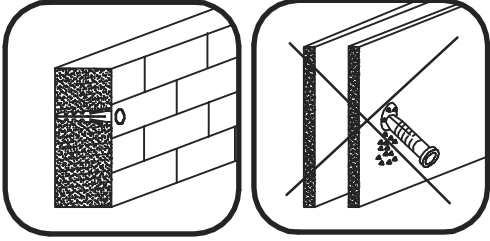
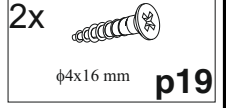
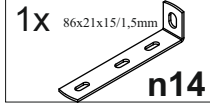
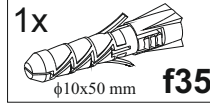
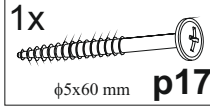

A

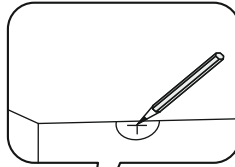

B

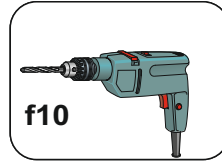

C

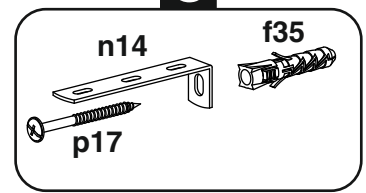

D

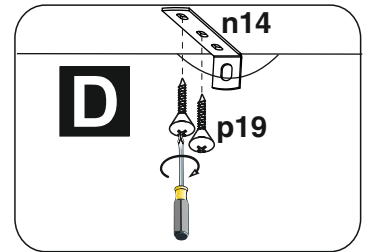



BG	Bulgarisch	български
CS	Tschechisch	čeština
DA	Dänisch	Dansk
DE	Deutsch	Deutsch
ET	Estonisch	Eesti
EL	Griechisch	ελληνικά
EN	Englisch	English
ES	Spanisch	español
FR	Französisch	Français
FI	Finnisch	suomalainen
HR	Kroatisch	hrvatski
HU	Ungarisch	magyar
IT	Italienisch	italiano
LV	Lettisch	Latvijas
LT	Litauisch	Lietuvos
NL	Niederländisch	Nederlands
PL	Polnisch	Polski
PT	Portugiesisch	português
RO	Rumänisch	român
SK	Slowakisch	slovenský
SL	Slowenisch	slovensčina
SV	Schwedisch	Svenska

